

hue

Seating

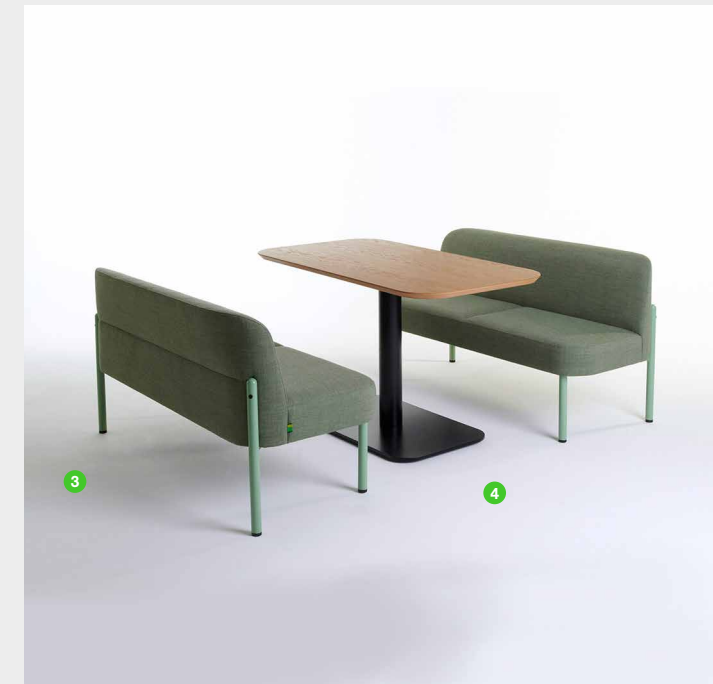

About Hue

Hue is designed for dividing, creating and utilising awkward space whilst encouraging collaboration at a higher posture. As a luxurious retreat for group or individual work, Hue is perfect for use in narrow spaces, and is ideally suited for pre and post meeting situations.

Part of the wider Hue range, Hue sofa has a fully upholstered seat with a steel frame that combine to make an attractive and comfortable sofa range available as standard or bar height.

Use Hue sofa with Hue table to create touch down points in awkward spaces.

Compliance

- SCS Indoor Advantage™ Gold Certificate
- FSC®certified products available upon request
- naughtone is FISP and ISO14001 certified

Sizes

All dimensions quoted are rounded to the nearest 5mm or nearest 1/2 inch

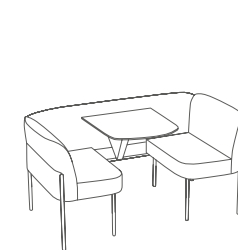

NOHES01
Hue with Steel Legs
mm W 1870 D 940 H 750 Seat 450
inch W 73.5 D 37 H 29.5 Seat 18

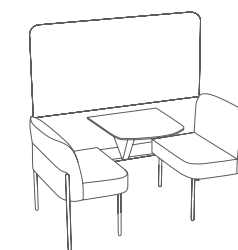

NOHES02
Hue with Screen and Steel Legs
mm W 1870 D 900 H 1495 Seat 450
inch W 73.5 D 35.5 H 59 Seat 18

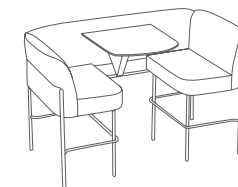

NOHES03
Hue Bar Height with Steel Legs
mm W 1870 D 940 H 1050 Seat 750
inch W 73.5 D 37 H 41.5 Seat 29.5

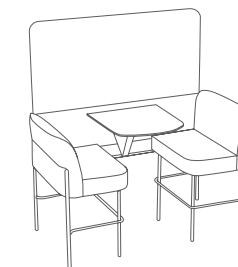

NOHES04
Hue Bar Height with Screen and Steel Legs
mm W 1870 D 900 H 1795 Seat 750
inch W 73.5 D 35.5 H 70.5 Seat 29.5

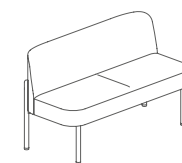

NOHES220
Hue Sofa with Steel Legs
mm W 1400 D 630 H 750 Seat 450
inch W 55 D 25 H 29.5 Seat 17.5

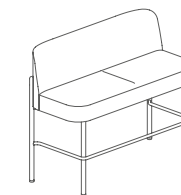

NOHES225
Hue Bar Height Sofa with Steel Legs
mm W 1400 D 630 H 1050 Seat 750
inch W 55 D 25 H 41.5 Seat 29.5

Table Top Options



White / Black MFMD
with reverse chamfer,
polished MDF edge



Oak Veneer
with reverse chamfer,
polished MDF edge



Walnut Veneer
with reverse chamfer,
polished MDF edge

Leg Finishes



White / Black Steel
Legs
Standard



RAL9006 Silver
Powder Coated Legs

Other Options

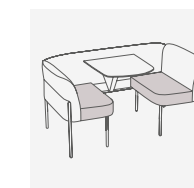

Two Tone
Back and Screen /
Seat Cushion

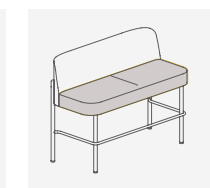

Two Tone
Back and Screen /
Seat Cushion

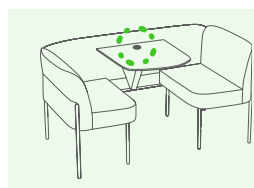

Power unit located centrally,
next to screen



hue

Seating and Table

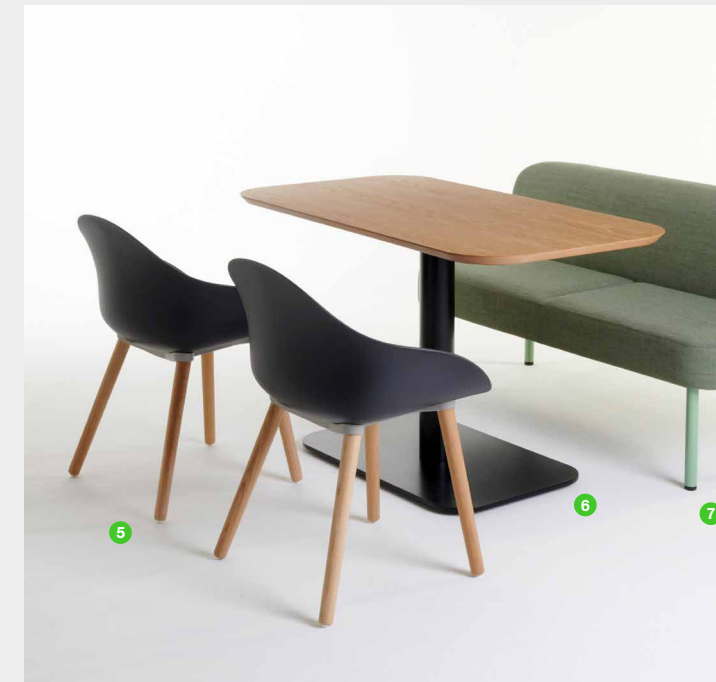

About Hue Table

With a pared-down elongated design and robust construction, the Hue table is perfectly suited to working or collaborating at a standard or bar height. The minimalistic soft rectangular shaped base and hollow stem allows for maximum leg space and can be fitted with power and data.

Use Hue sofa with Hue table to create touch down points in awkward spaces.

Compliance

- SCS Indoor Advantage™ Gold Certificate
- FSC®certified products available upon request
- naughtone is FISP and ISO14001 certified

Sizes

All dimensions quoted are rounded to the nearest 5mm or nearest 1/2 inch

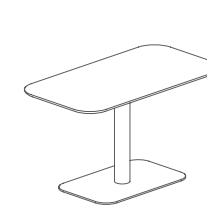

NOHEST10
Hue Rectangular Table
mm W1300 D700 H750
inch W51 D27.5 H29.5

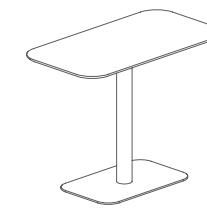

NOHEST210
Hue Rectangular Bar Height Table
mm W1300 D700 H1000
inch W51 D27.5 H39.5

Base Finishes



White Powder Coated Base and Stem
Standard



Black Powder Coated Base and Stem
Standard

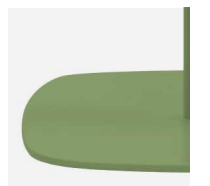

RAL Powder Coated Base and Stem
naughtone Colours

Top Options



White / Black MFMDF
with reverse chamfer,
polished MDF edge



Oak Veneer
with reverse chamfer,
polished MDF edge



Walnut Veneer
with reverse chamfer,
polished MDF edge

Power and Data

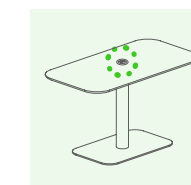

Power unit located centrally.















Hue Seating Technical Specifications

Testing

- Seat and back static load test
- Seat front edge static load test
- Vertical static load on back
- Foot rest and leg rest static load test
- Arm sideways static load test
- Arm downwards static load test
- Vertical upwards static load on arm rests
- Seat and back durability test
- Seat front edge durability test
- Leg forward static load test
- Leg sideways static load test
- Seat impact test
- Back impact test
- Arm impact test

Structural Testing Certifications

NOHES04

Hue bar height with screen

Seating elements tested to EN 16139:2013 Level 2

Table elements tested to EN 15372:2016

Screen element tested to EN 1023-2:2000

Static Load 200kg

Hue Table

BS EN 15372:2016 - Level 2

Static load 120kg

Hue Sofa

BS EN 16139:2013 - Level 1

Static load 320kg

ANSI/BIFMAX5.4-2020

Static load 300lbs

Flammability

The cold cure foam material has been tested to meet the following standards:

British standard
5852:2006 Part 2

California Technical Bulletin
117-2013

Italian standards
UNI 9175-CLASS 1.IM

The flammability standard of the covering fabric is dependent on the choice made by the customer, details of the flammability rating of specific fabrics can be found on supplier's websites listed below.

www.kvadrat.dk

www.camirafabrics.com

www.butefabrics.com

www.panaz.com

www.maharam.com

www.vescom.com

www.ultrafabricsllc.com

www.crestleather.com



Servicing

If a component is damaged and needs replacing then please email our team with an image of the damaged part and reference your order number, we will be happy to facilitate any replacements.



Warranty

naughtone offers a **10 Year** warranty across all products. Details on the terms and conditions of naughtones warranty can be found at naughtone.com/warranty

Hue Seating Technical Specifications

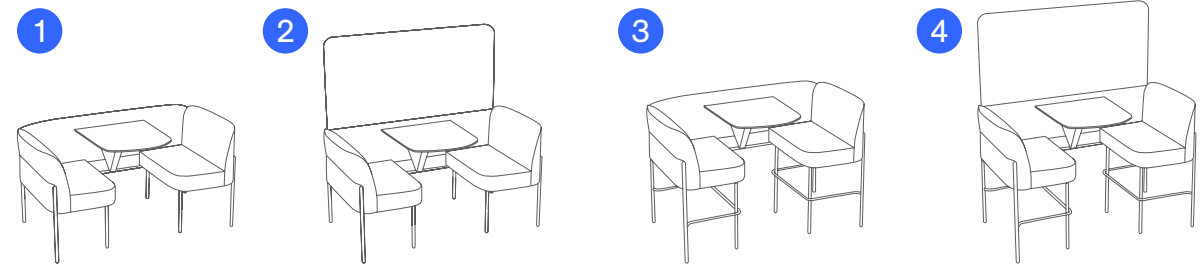

Product Code and Description <small>All dimensions quoted are rounded to the nearest 5mm or nearest 1/2 inch</small>	A Width	B Depth	C Height Overall	D Seat Height	E Height from Seat to Top of Back	F Table Length	G Table Width	H Table Height	I Space Between Sofas	J Weight
1 NOHES01 Hue with Steel Legs	1870 mm 73.5 in	940 mm 37 in	750 mm 29.5 in	450 mm 18 in	300 mm 12 in	720 mm 28.5 in	700 mm 27.5 in	700 mm 27.5 in	650 mm 25.5 in	85.5 kg 188.5 lbs
2 NOHES02 Hue with Screen and Steel Legs	1870 mm 73.5 in	900 mm 35.5 in	1500 mm 59 in	450 mm 18 in	300 mm 12 in	720 mm 28.5 in	700 mm 27.5 in	700 mm 27.5 in	650 mm 25.5 in	110.2 kg 242.9 lbs
3 NOHES03 Hue Bar Height with Steel Legs	1870 mm 73.5 in	940 mm 37 in	1050 mm 41.5 in	750 mm 29.5 in	300 mm 12 in	720 mm 28.5 in	700 mm 27.5 in	1000 mm 39.5 in	650 mm 25.5 in	91.1 kg 200.8 lbs
4 NOHES04 Hue Bar Height with Screen and Steel Legs	1870 mm 73.5 in	900 mm 35.5 in	1800 mm 70.5 in	750 mm 29.5 in	300 mm 12 in	720 mm 28.5 in	700 mm 27.5 in	1000 mm 39.5 in	650 mm 25.5 in	115.8 kg 255.3 lbs

Measuring Guide

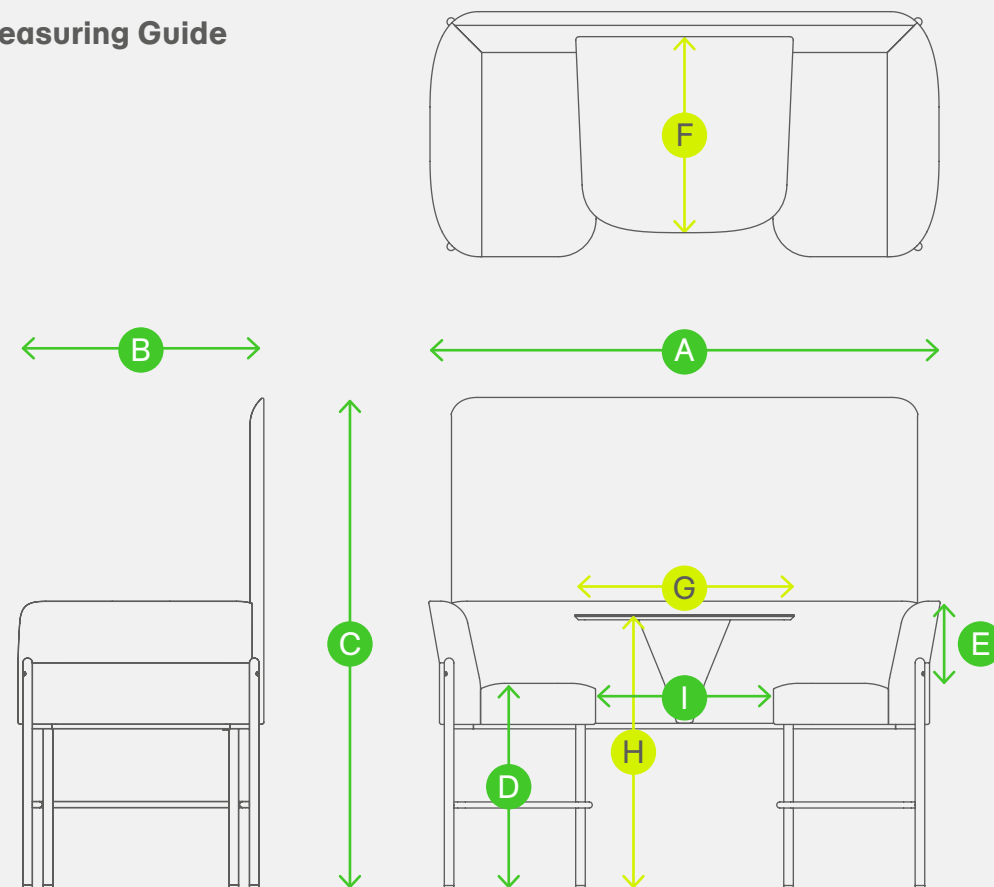

Hue Sofa Technical Specifications

5

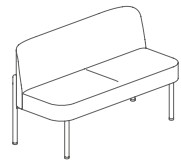

6

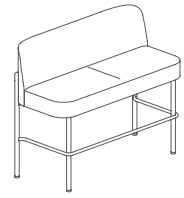

Product Code and Description <small>All dimensions quoted are rounded to the nearest 5mm or nearest 1/2 inch</small>	A Width	B Depth	C Height Overall	D Seat Height	E Height from Seat to Top of Back	F Weight
6 Hue Sofa with Steel Legs	1400 mm 55 in	630 mm 25 in	750 mm 29.5 in	450 mm 18 in	300 mm 12 in	36 kg 79.3 lbs
7 Hue Bar Height Sofa with Steel Legs	1400 mm 55 in	630 mm 25 in	1050 mm 41.5 in	750 mm 29.5 in	300 mm 12 in	39 kg 86 lbs

Hue Table Technical Specifications

7



8

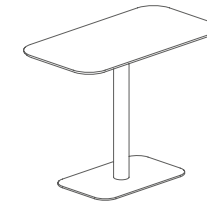

Product Code and Description <small>All dimensions quoted are rounded to the nearest 5mm or nearest 1/2 inch</small>	A Width	B Depth	C Height Overall	D Distance from Floor to Underside	E Width of Overhang of Top at Widest Point	F Depth of Overhang of Top at Widest Point	G Width of Splay of Base at Widest Point	H Depth of Splay of Base at Widest Point	I Weight
7 Hue Rectangular Table	1300 mm 51 in	700 mm 27.5 in	750 mm 29.5 in	725 mm 28.5 in	250 mm 10 in	100 mm 4 in	800 mm 31.5 in	500 mm 19.5 in	41 kg 90.4 lbs
8 Hue Rectangular Bar Height Table	1300 mm 51 in	700 mm 27.5 in	1000 mm 39.5 in	975 mm 38.5 in	250 mm 10 in	100 mm 4 in	800 mm 31.5 in	500 mm 19.5 in	43 kg 94.8 lbs

Measuring Guide

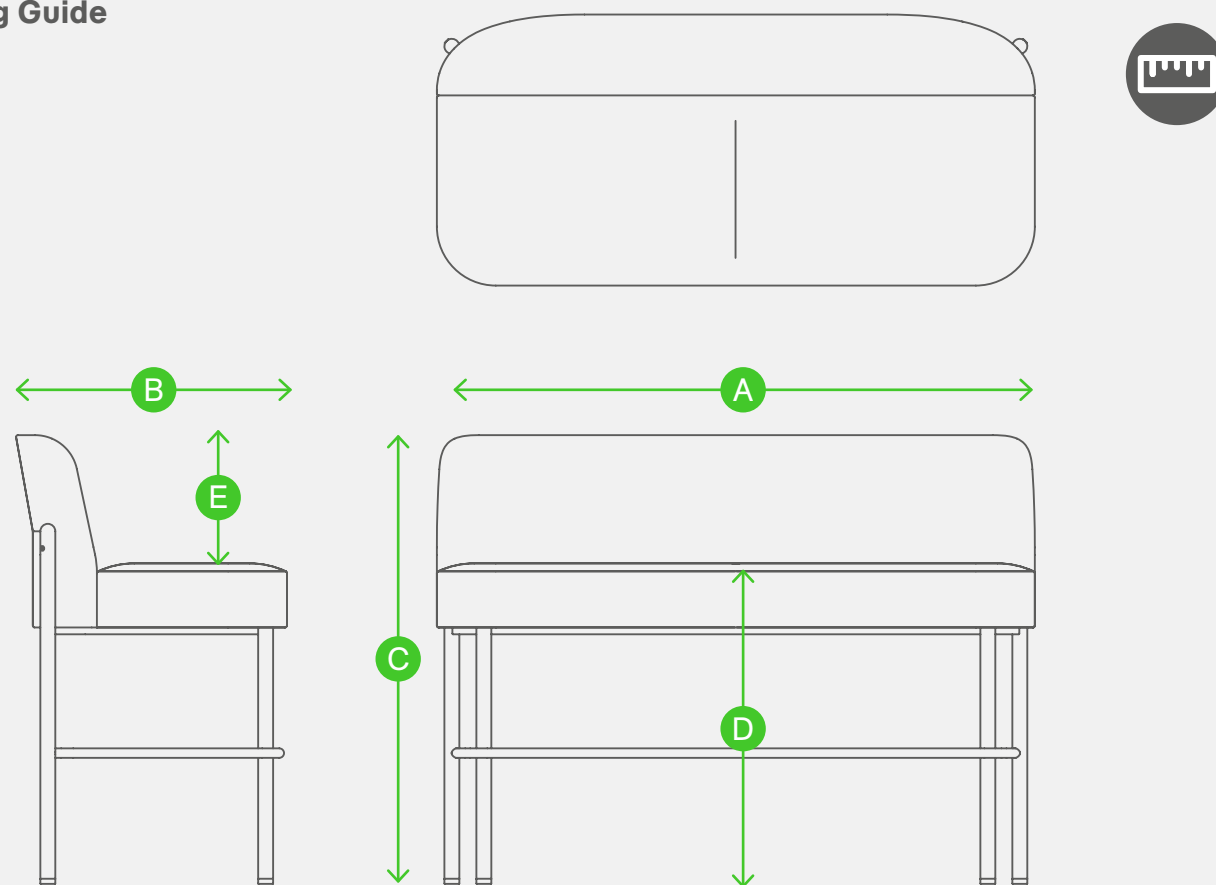

Measuring Guide

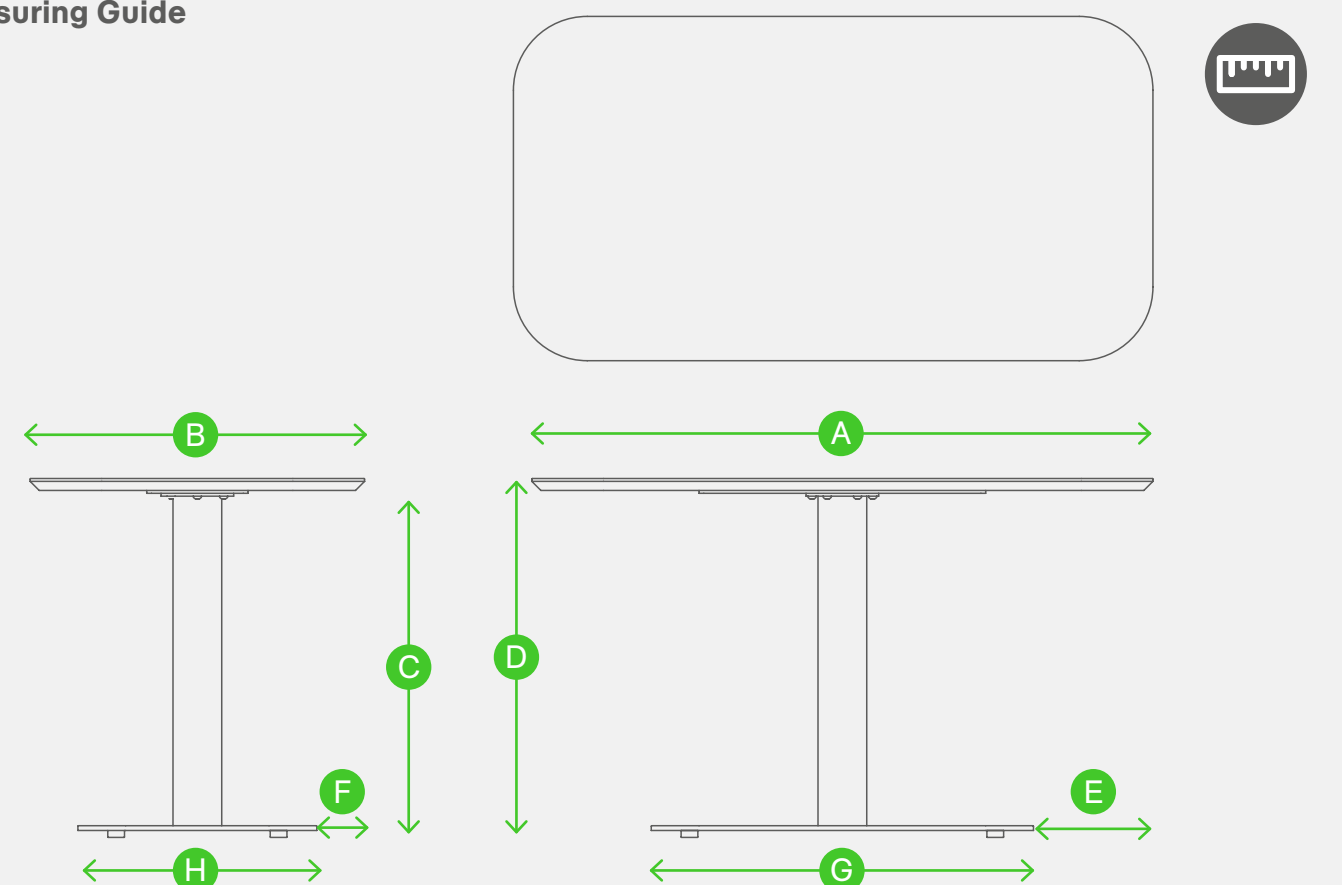

Hue Seating Environmental Product Summary



Hue Seating Environmental Product Summary

Material Percentage Split

- 58.1% Beech Plywood
- 4.2% Foam
- 20.6% Mild Steel
- 0.6% Felt
- 8.3% Fabric
- 0.5% Stainless Steel
- 7.2% Medium Density Fibreboard
- 0.1% Polypropylene

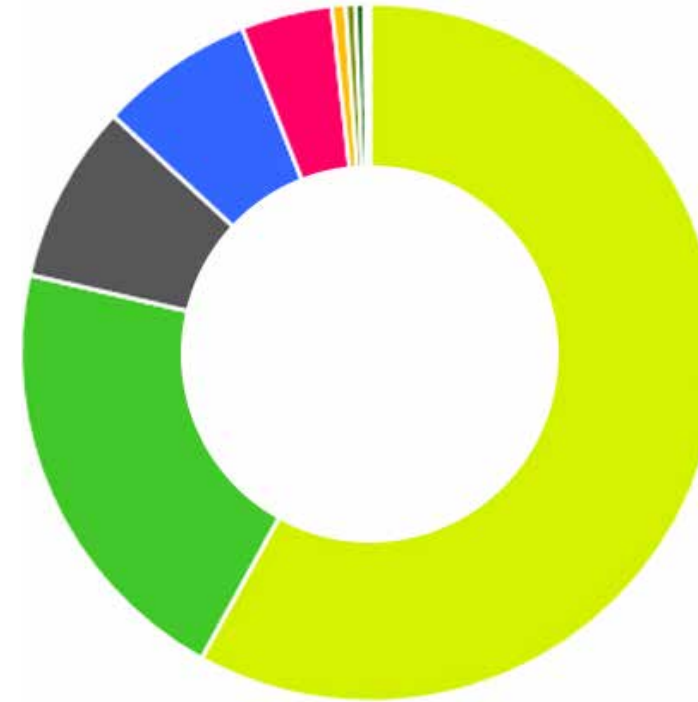

Post Consumer Recycled Content

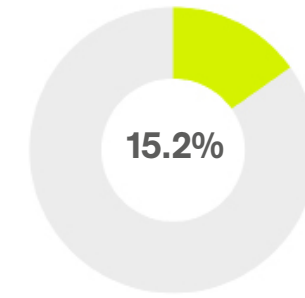

Recyclable Content

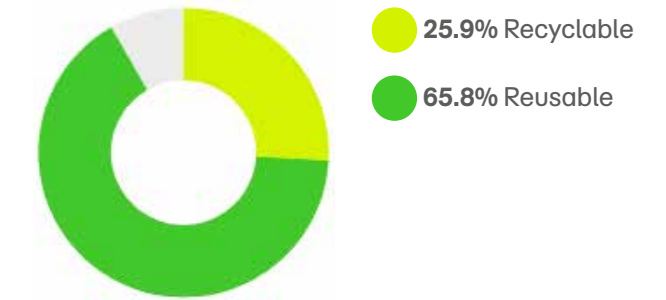

Environment Attributes

- naughtone is **FISP** and **ISO14001** certified
- naughtone is **FSC®** certified
- **115.8kg** total weight
- **25.9% Recyclable** (fixings, legs, brackets and plastic fixtures)
- **65.8% Reusable** (frame, table top)
- **15.2% Recycled Content** (fixings, legs, brackets, plastic fixtures and table top)

These attributes can help you to achieve criteria towards **LEED, BREEAM, Ska** and **WELL** building certifications



CSR Statement

naughtone has always considered the environment throughout our design and manufacturing process. We understand that as we continue to grow, so does our potential impact on our surroundings. As most of our raw materials are simple, we have great control over their sources, and are proud to be able to offer **FSC® certified** upholstered products and use recycled metals in our table ranges. The addition of our North American manufacturing provision also helps to keep manufacturing miles to a minimum, as our market continues to grow in the USA. Finally, naughtone offers a 'bring back' programme, where the client is able to return the product to our factory, where we will be happy to breakdown and recycle the parts for you.

Product Specific Design Statement

Hue is available in a range of sizes and finishes but for the purpose of this document we have a specific example from the range:

Hue Bar Height with Screen

The inner frame of Hue is constructed from plywood then topped with high quality foams before being upholstered.

The Hue steel frame and legs are made from mild steel tube with the individual laser cut components being folded allowing for minimal additional welding. The legs are finished with a polyester powder coat.

The table top is CNC cut from oak veneer with the raw edge polished and finished with a hard-wearing spray lacquer.



FSC® certified products available upon request



naughtone offers PEFC certified products



Where sustainable sources are quoted, and a chain of custody is required by a customer this must be indicated on the purchase order to naughtone. A chain of custody requested after an order has been placed or delivered may be difficult to recover.

Figures stated in the Environmental product summary may vary based on model and options selected, we have based this document on a specific example when produced in the United Kingdom. Recycled content calculations are taken from supplier information and industry averages, material variables are likely to affect the figures which may result in higher or lower percentages.

This document will be reviewed and updated periodically and is subject to change without notice.



1 Design

Every aspect of the naughtone product ranges has been designed with the environment considered, from ethical material choice and production efficacy to storage efficiency and ease of disassembly.

Dense foam sets and resilient fabrics are selected for their longevity and effectiveness across sectors. Durable high quality finishes such as powder coated bases in a range of colours allow clients the freedom of finish options. Finish samples are available allowing clients to make informed decisions and retain to add to their finish libraries for future reference.

2 Raw Material

Local supply of raw materials is employed for the production of our products when possible, procured from suppliers that are quality inspected for extraction methods and meet the highest environmental standards.

3 Production

As many of our products are assembled by hand the energy expenditure wasted from machinery during the production process is kept to a minimum.

All fabrics are cut to ensure optimum efficiency with fabric usage and reduced waste consumption per unit.

All production sites have recycling facilities for any excess product that cannot be used elsewhere, which is then managed by a professional third party.

4 Distribution

Distribution of naughtone products generally occurs directly between the manufacturing site to the client. Production is localised when possible to the US or UK regions, reducing the carbon footprint and miles travelled for each product.

Many items are flat packed for delivery or shipped disassembled with efficient, minimised packaging; optimizing the transportation vessel space.

5 Usage

naughtone products do not require energy or water to function, thus no environmental exchange takes place and no waste is generated during the life of the product.

The only foreseeable need is the cleaning of the product for general maintenance. This includes regular vacuuming to remove dirt and dust particles on upholstery items, and using a dry or damp cloth to wipe non-upholstery items.

This is recommended for all products utilised under conditions of normal wear and is expected to have negligible environmental impacts.

6 End of Life

Although our products are durable and demonstrate timeless design, naughtone products are manufactured in such a way that they can be easily disassembled at the end of life and most of the componentry can be either recycled or re-used as applicable.

As a company we are also happy to accept the return of products, to help re-home or recycle furniture or components at the end of the products useful life.

UK Showroom

6 Bakers Yard
Clerkenwell
London EC1R3DD
T: +44 (0)20 389 22 788

US Showroom

Suite 11-88
222 Merchandise Mart Plaza
Floor 11
Chicago IL 60654

naughtone HQ

Knaresborough Tech Park
Manse Lane
Knaresborough HG5 8LF

T: +44 (0) 1423 816 500
E: sales@naughtone.com

www.naughtone.com